

32-1131 REV 1



Series R02 button type smart sensors are designed for compression measurement applications in virtually every industry. Compact and rugged, Series R02 sensors are ideal for heavy duty applications with space constraints. Capacities available from 100 to 10,000 lbF [500 N to 50 kN]. Compatible with Mark-10 indicators (sold separately) through unique Plug & Test™ technology.



< Unique Plug & Test™ technology allows for interchangeable sensors to be used with a Mark-10 indicator. All calibration and configuration data is saved in the smart connector.



< The Plug & Test™ connector locks into the receptacle in the indicator when fully inserted. Dual buttons on the indicator housing release the connector for easy removal. Gold plated spring contacts ensure long lasting and reliable connection.

Specifications

Accuracy:	±0.5% of full scale + indicator
Safe Overload:	150% of full scale
Weight:	MR02-100 - MR02-2000: 0.3 lb [0.1 kg] MR02-5000-MR02-10000: 0.5 lb [0.2 kg]

Dimensions in [mm]

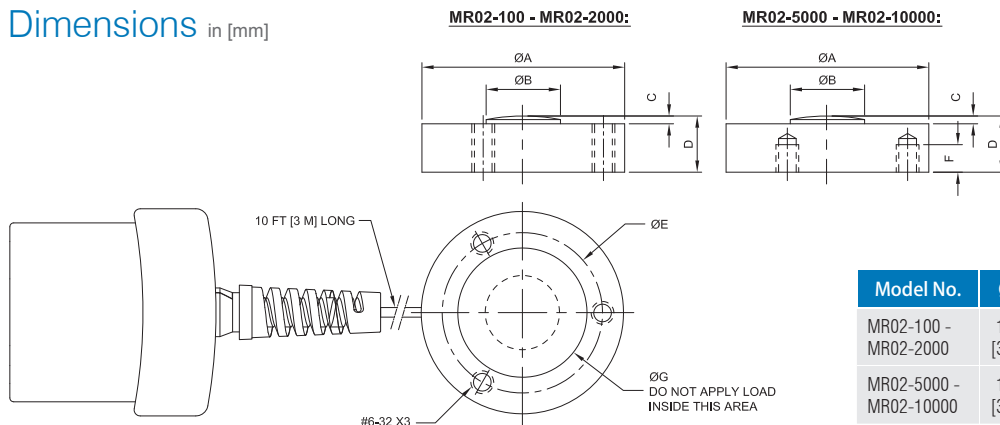

Model No.	ØA	ØB	C	D	ØE	F	ØG
MR02-100 - MR02-2000	1.23 [31.3]	0.32 [8.1]	0.05 [1.3]	0.39 [9.9]	1.0 [25.4]	THRU	0.83 [21.1]
MR02-5000 - MR02-10000	1.48 [37.6]	0.43 [10.9]	0.07 [1.8]	0.62 [15.8]	1.25 [31.8]	0.25 [6.4]	1.08 [27.4]

Capacity x Resolution

Model No.	With Models 71 & 5i Indicators						With Model 3i Indicator			
	lbF	ozF	gF	kgF	N	kN	lbF	kgF	N	kN
MR02-100	100 x 0.05	1600 x 1	50000 x 20	50 x 0.02	500 x 0.2	-	100 x 0.1	50 x 0.05	500 x 0.5	-
MR02-200	200 x 0.1	3200 x 2	-	100 x 0.05	1000 x 0.5	1 x 0.0005	200 x 0.2	100 x 0.1	1000 x 1	-
MR02-500	500 x 0.2	8000 x 5	-	250 x 0.1	2500 x 1	2.5 x 0.001	500 x 0.5	250 x 0.2	2500 x 2	-
MR02-1000	1000 x 0.5	16000 x 10	-	500 x 0.2	5000 x 2	5 x 0.002	1000 x 1	500 x 0.5	5000 x 5	-
MR02-2000	2000 x 1	32000 x 20	-	1000 x 0.5	10000 x 5	10 x 0.005	2000 x 2	1000 x 1	10000 x 10	-
MR02-5000	5000 x 2	-	-	2500 x 1	25000 x 10	25 x 0.01	5000 x 5	2500 x 2	-	25 x 0.02
MR02-10000	10000 x 5	-	-	5000 x 2	50000 x 25	50 x 0.02	10000 x 10	5000 x 5	-	50 x 0.05